

Stückliste „Erdschrauben-Fundament“ für Gerätehäuser „HighLine®“ und „AvantGarde®“

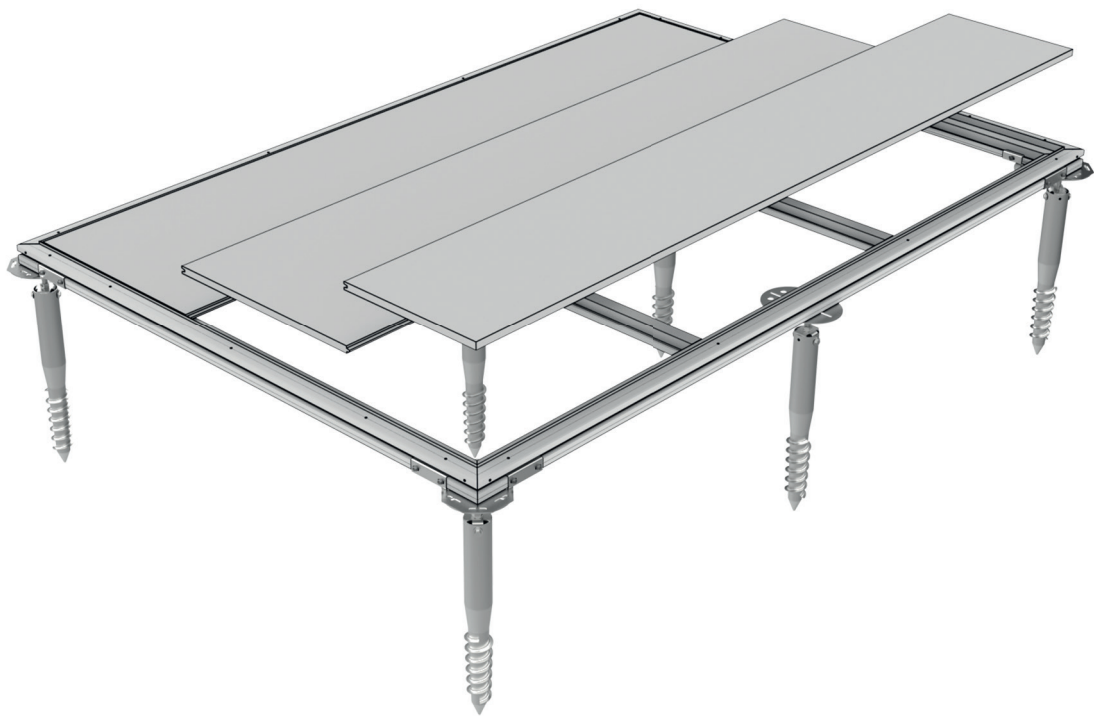



Paket Nr. 1

Erdschraubenpaket · ground screw package · carton de vis de fondation · grondschroefpakket ·
paquete de láminas · pacco viti di ancoraggio a terra

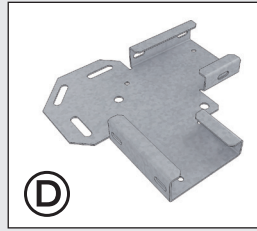
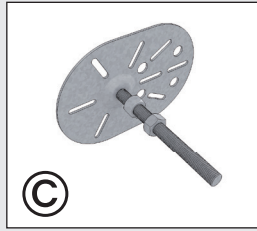
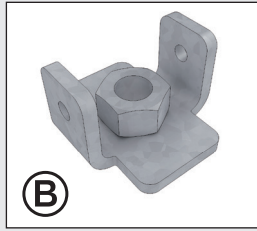
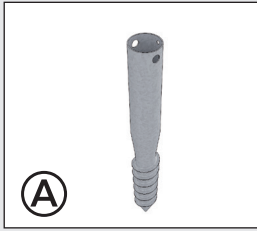

Paket Nr. 2

Profilpaket · profile package · carton de profils · profielpakket · pacco profili · kit de perfiles

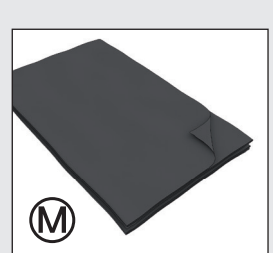
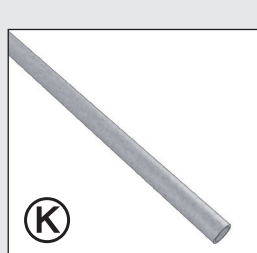
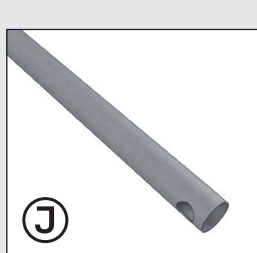
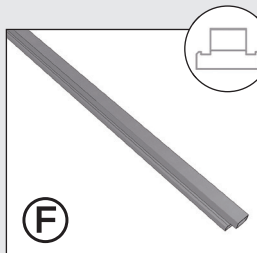
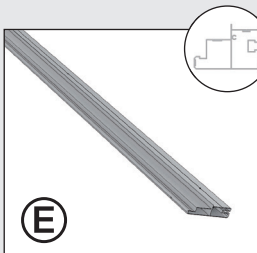

Paket

Plattenpaket · panel package · carton de plaques · platenpakket · paquete de tornillos ·
pacco lamiera

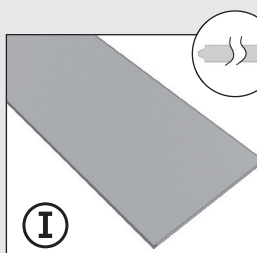
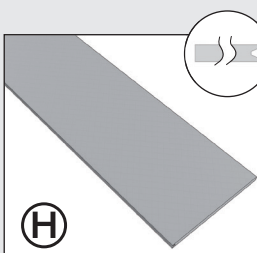

Paket Nr.	Pos.-Nr.	Artikel-Nummer	Maße (mm)	Artikelname	GHA M	GHH 1	GHH 2/ GHAL	GHH 3	GHH 4/ GHA XL	GHH 5	GHA XXL
Paket Nr. 1 Erdschraubenpaket 43437(GHA M) 43413(GHH1/2/3/GHA L) 43466(GHH4/GHA XL) 43431(GHH 5) 43467(GHA XXL)	A	XT703700	/	Erdschraube	6	7	7	7	9	11	12
	B	XT700711	/	Gewindeinsatz dm 60	6	7	7	7	9	11	12
	C	XT700720	/	Adapterplatte	6	7	7	7	9	11	12
	D	XT700701	/	Eckverbinder	4	4	4	4	4	4	4
	G	XT700702	/	Befestigungswinkel	3	5	5	5	9	11	12
	U	X0001007	/	Vorlegeband	1	1	1	1	1	1	1
	D1	XT700751	/	Schraubenpaket	1	1	1	1	1	1	1

Paket Nr.	Pos.-Nr.	Artikel-Nummer	Maße (mm)	Artikelname	GHA M	GHH 1	GHH 2/ GHAL	GHH 3	GHH 4/ GHA XL	GHH 5	GHA XXL	
Paket Nr. 2 Profilpaket 43447(GHA M) 43453(GHH 1) 43459(GHH 2/GHA L) 43464(GHH 3) 43469(GHH 4/GHA XL) 43475(GHH 5) 43479(GHA XXL)	E	XT700602	1320	Fundamentprofil		2						
		XT700604	1720		4	2						
		XT700605	2120				2					
		XT700607	2520			2	2	4	2	2		
		XT700608	2920								2	
		XT700610	3320									2
F	XT700637	1154	Fundamentstrebe		2							
	XT700632	1554		1	2							
	XT700638	1954				2						
	XT700634	2354							2			
	XT700639	2754									2	
J	XT700714	/	Eindrehstange	1	1	1	1	1	1	1		
K	XT700715	/	Hebelstange	1	1	1	1	1	1	1		
M	XT700401	800	Dichtfolie									
	XT700411	1900		1	1							
	XT700413	3000						1	1	1	1	
L	A4003034	/	Schraube M16x80+Mutter	1	1	1	1	1	1	1		



Paket Nr.	Pos.-Nr.	Artikel-Nummer	Maße (mm)	Artikelname	GHA M	GHH 1	GHH 2/ GHA L	GHH 3	GHH 4/ GHA XL	GHH 5	GHA XXL		
Paket Nr. Plattenpaket 43448(GHA M) 43449(GHA M) 43454(GHH 1) 43455(GHH 1/2/5/GHA L) 43460(GHH2/3/4/5/GHA L/XL/XXL) 43465(GHH3/4/GHA XL/XXL)	H	XT300653	1620x 420	Fundamentplatte mit Nut	1								
		XT300658	2420x 420			1	1	1	1	1	1		
	I	XT300654	1620x 600		2								
		XT300657	2420x 400			2				1	2		1
		XT300659	2420x 600					2		2	2	4	4

Paket Nr.	Artikel-Nummer	Artikelname	Stk.
D1 Schraubenpaket XT700551 	A51016	Sechskantschrauben M8x16	25
	A4005014	BEILAGSCHEIBE 8,4 x 24 x 2 mm	25
	A4002022	Torbanschraube M8x20	35
	A4003033	SK-MUTTER M8 Sperrzahn mit Flansch	35
	A4003032	Blechschaube 6.3x22 mit Sechskant und Bohrspitze	75
	A4005010	Beilagscheibe 6,6 x 22 x 2 MM	25
	A4003030	Flügelbohrschraube Senkkopf 5,5x50 vz mit Rippen	50
	A4003035	Linseblechschaube 4,8x60 TX 25 verzinkt	4